

FEM-C 4-7



Sample image

Order symbol : FEM-C 4-7

Product nr : 3545088

Description : Chloroprene Cable gland M12

Remarks : for cable 4-7 mm

EAN : 6418074035561

El. number :

- Finland : 1722321
- Denmark : 8213001092
- Sweden : 1458370

CR, RAL 9005, IP 67 (EN 60529), Wall thickness 0,5 - 5 mm, Temperature range -30°...+100°C

Code	Order symbol	EAN	Size	Cable diameter	A mm	B mm	Da mm	H mm	H1 mm	Pcs/pack
3545088	FEM-C 4-7	6418074035561	M12	4-7	12,5	0,5-2	20	12,7	5,4	50
3545089	FEM-C 5-9	6418074035578	M16	5-9	16,5	1-4	21	18	10,5	50
3545288	FEM-C 4-7 L	6418074070463	M12	4-7	12,5	2-5	20	12,7	5,4	50
3545289	FEM-C 5-9 L	6418074070579	M16	5-9	16,5	2-5	21	18	10,5	50
3545090	FEM-C 8-13	6418074035585	M20	8-13	20,5	1-4	25,5	20	12,7	50
3545091	FEM-C 10-14/PG 16	6418074035592	PG16	10-14	23	1-4	28	21,6	14,7	50
3545092	FEM-C 11-17	6418074035608	M25	11-17	25,5	1-4	30,5	21,6	14,5	50
3545093	FEM-C 15-20	6418074035615	M32	15-20	32,5	1-4	38,5	24,8	17,5	25
3545094	FEM-C 19-28	6418074035622	M40	19-28	40,5	1-4	48,5	30	20,4	25
3545095	FEM-C 27-35	6418074035639	M50	27-35	50,5	1-4	60,5	35	23,9	10
3545104	FEM-C 34-45	6418074070869	M63	34-45	63,5	1-4	73,5	40	28,9	5

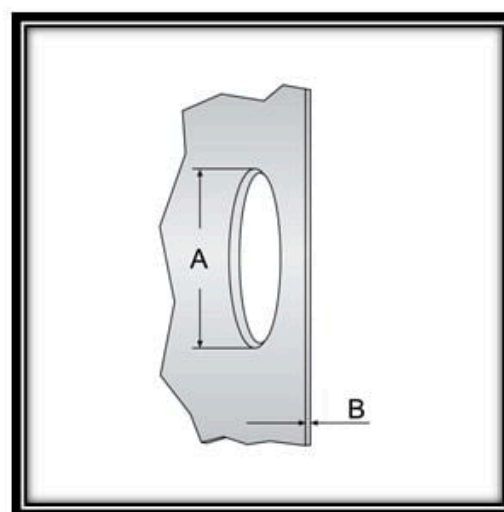
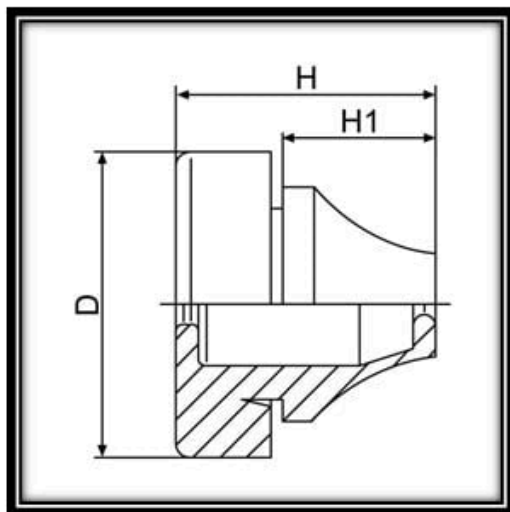

Dimensions :

	Height	Width	Depth
mm :	20	20	13
inch :	0.79	0.79	0.51

Ratings :

Ingress protection (EN 60529):	IP67;
electrical_insulation :	Not insulated
UV resistance :	-
Flammability Rating :	UL 94 HB

Materials :

Material :	EPDM
------------	------