

MB 10892 SET



Sample image

Order symbol : MB 10892 SET

Product nr : 3590892

Description : Size 1

Remarks : incl. flange, gasket and connector set

EAN : 6418074056665

El. number :

- Finland : 3413028
- Denmark : 8212009338
- Sweden : 2650028

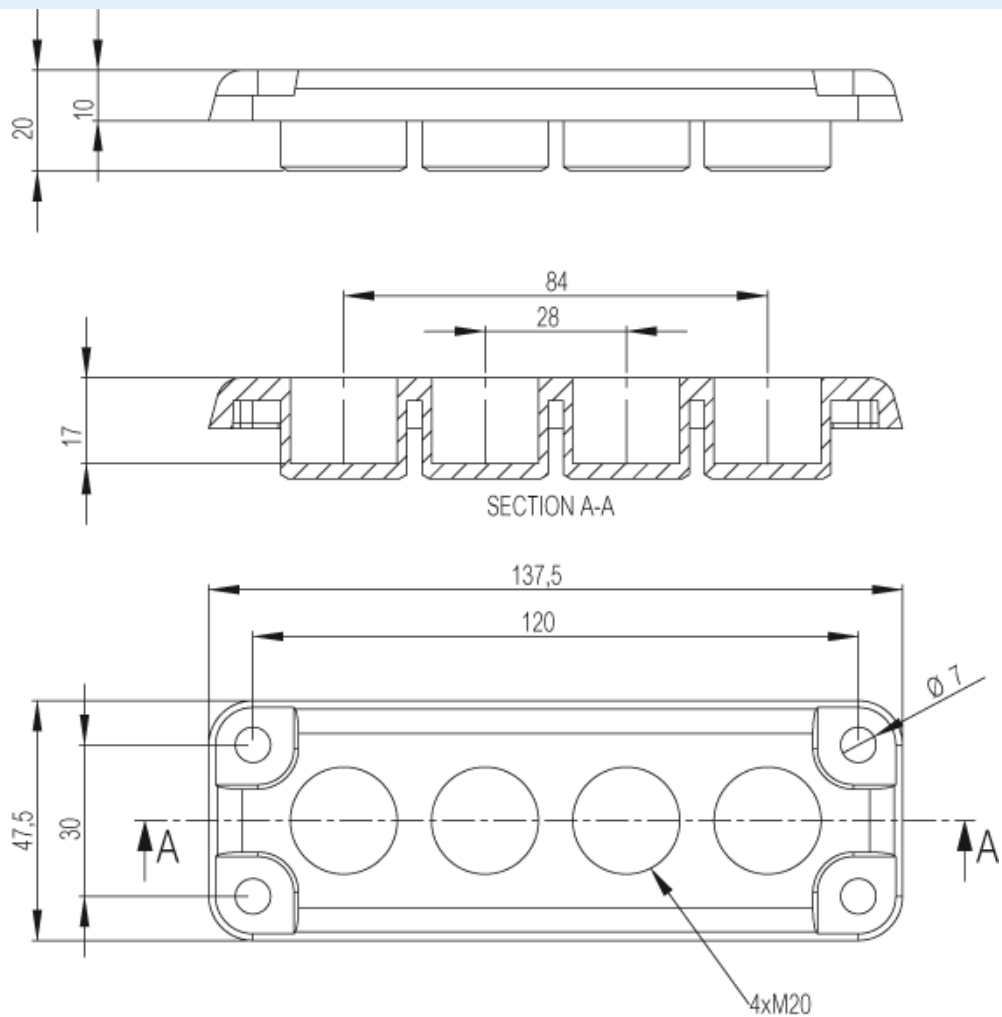

Dimensions :

	Height	Width	Depth
mm :	140	49	10
inch :	5.51	1.93	0.39

Ratings :

Ingress protection (EN 60529):	IP65;
Impact Resistance (EN 62262):	IK08;
electrical_insulation :	Not insulated
UV resistance :	-

Materials :

Material :	Polycarbonate
Gasket material :	EPDM

Temperatures :

Temperature °C (continuous) :	-40 ... 80
Temperature °F (continuous) :	-40 ... 175