

PCM 200/125 XT



Sample image

Order symbol : PCM 200/125 XT

Product nr : 6015927

Description : Enclosure, PC, metric knock-outs

Remarks : Extra high base, smoked transparent cover

EAN : 6418074038401

El. number :

- Finland : 3421628
- Denmark : 8212027378
- Sweden : 2535460

Including : Base with TPE gasket. screws for mounting plate/DIN-rail and cover with polyamide cover screws.

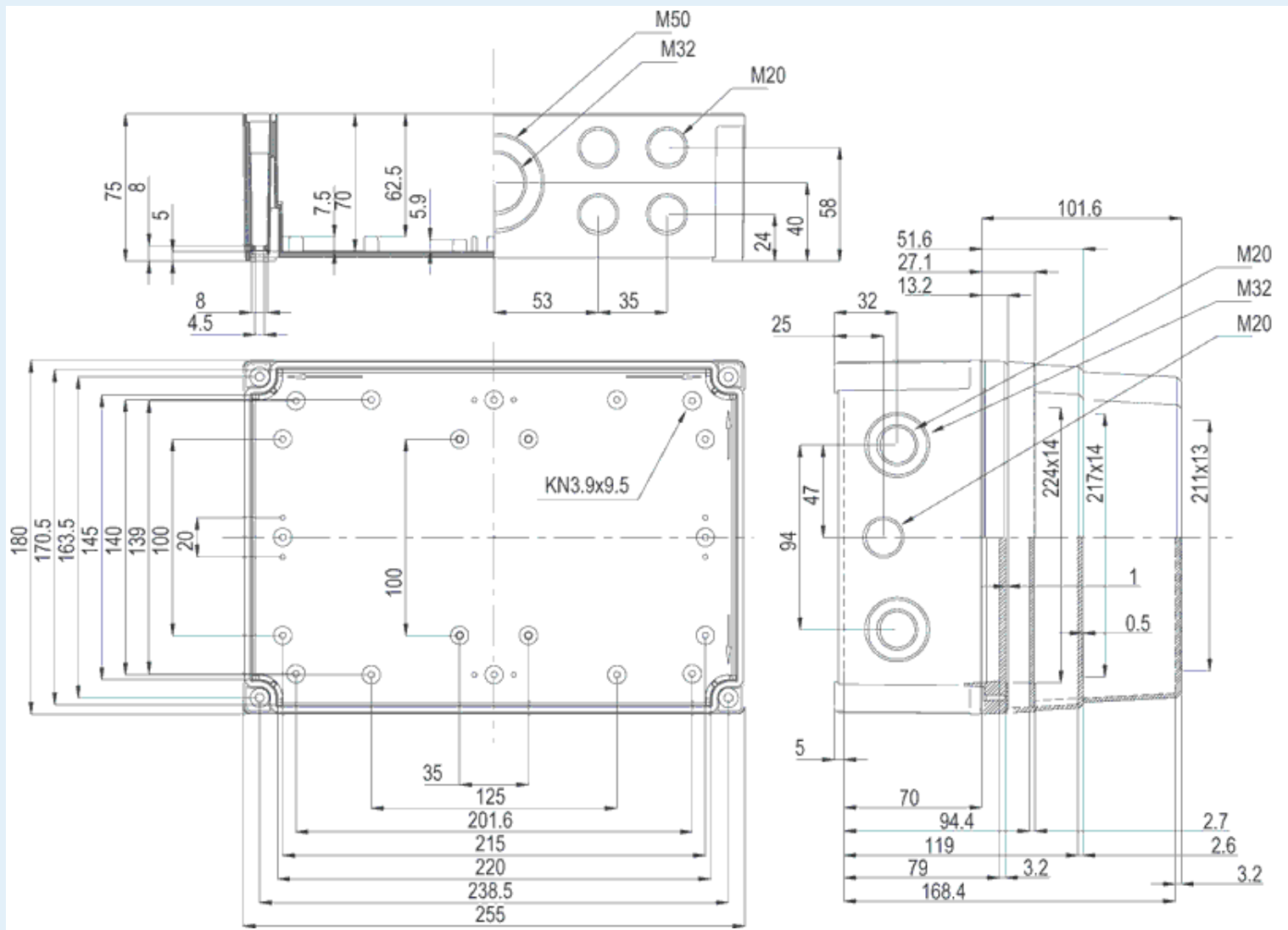

Dimensions :	Height	Width	Depth
mm :	255	180	125
inch :	10.04	7.09	4.92

Materials :

Material :	Polycarbonate
Base colour :	RAL_7035
Cover colour :	Smoked grey
Gasket material :	TPE

Temperatures :

Temperature °C (continuous) :	-40 ... 80
Temperature °F (continuous) :	-40 ... 175

Accessories :

MIV 200	Mounting plate (Galvanized steel), for enclosures: (223 x 148 x 1.5)
MIV 15	DIN-35 Mounting rail, for enclosures: (150 x 35 x 7)
FP 22046	Wall fastening lug (4 pcs) (35 x 16 x 10)
MIV 20	DIN-35 Mounting rail, for enclosures: (225 x 35 x 7)

Ratings :

Ingress protection (EN 60529):	IP66; IP67;
Impact Resistance (EN 62262):	IK08;
electrical_insulation :	Totally insulated
Halogen free (DIN/VDE 0472, Part 815) :	Yes
UV resistance :	UL 746C
Flammability Rating :	UL 94 V0
Glow Wire Test (IEC 695-2-1) °C :	960C

Certificates :

