

# PCM 175/85 XG

Sample image

**Order symbol :** PCM 175/85 XG

**EAN :** 6418074011794

**Product nr :** 6016339

**Description :** Enclosure, PC, metric knock-outs

**Remarks :** Grey cover

**Including :** Base with TPE gasket. screws for mounting plate/DIN-rail and cover with polyamide cover screws.

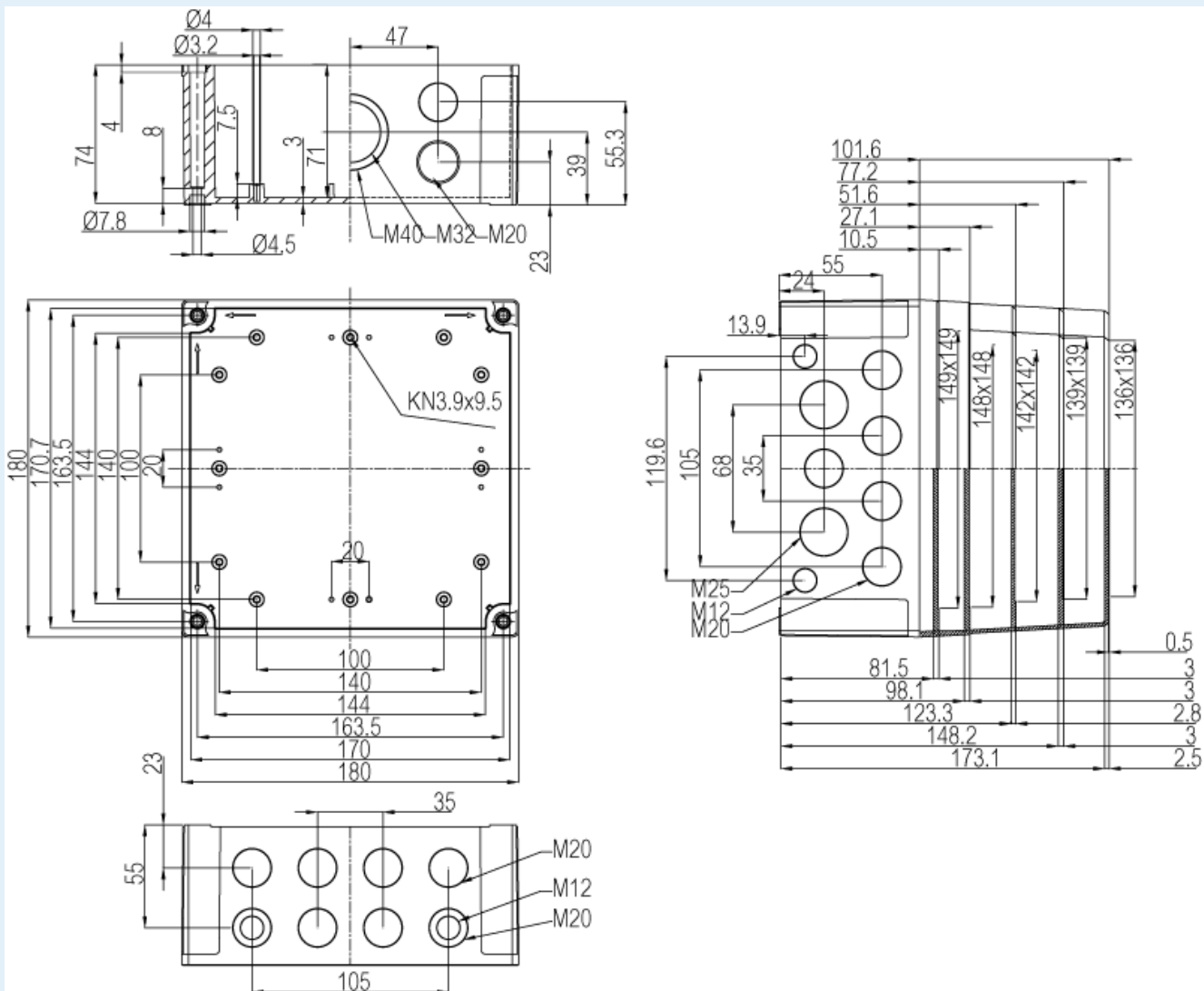

Dimensions :	Height	Width	Depth
mm :	180	180	85

Accessories :
MIV 175 Mounting plate (Galvanized steel), for enclosures:

inch : 7.09 7.09 3.35

**Materials :**

Material : Polycarbonate  
Base colour : RAL\_7035  
Cover colour : RAL 7035 -light grey  
Gasket material : Polyurethane

**Temperatures :**

Temperature °C (continuous) : -40 ... 80  
Temperature °F (continuous) : -40 ... 175

(148 x 148 x 1.5)

MIV 15 DIN-35 Mounting rail, for enclosures:  
(150 x 35 x 7)

FP 22046 Wall fastening lug (4 pcs)  
(35 x 16 x 10)

**Ratings :**

Ingress protection (EN 60529): IP66; IP67;  
Impact Resistance (EN 62262): IK08;  
electrical\_insulation : Totally insulated  
Halogen free (DIN/VDE 0472, Part 815) : Yes  
UV resistance : UL 746C  
Flammability Rating : UL 94 V0  
Glow Wire Test (IEC 695-2-1) °C : 960C

**Certificates :**

Certificate FI 40847