

PCM 175/125 XG

Sample image

Order symbol : PCM 175/125 XG

EAN : 6418074011817

Product nr : 6016341

Description : Enclosure, PC, metric knock-outs

Remarks : Grey cover

Including : Base with TPE gasket. screws for mounting plate/DIN-rail and cover with polyamide cover screws.

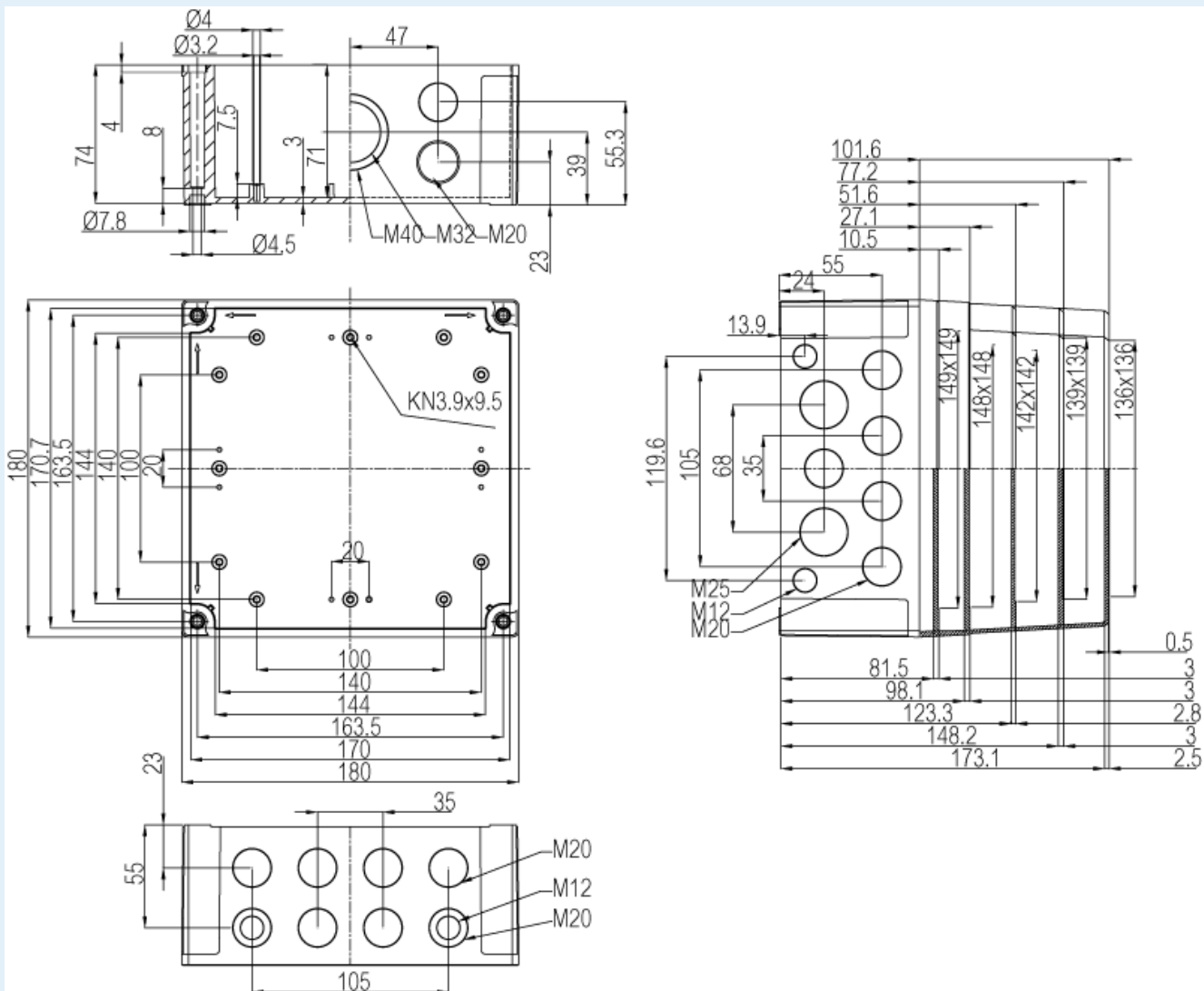

Dimensions :	Height	Width	Depth
mm :	180	180	125

Accessories :
MIV 175 Mounting plate (Galvanized steel), for enclosures:

inch : 7.09 7.09 4.92

Materials :

Material : Polycarbonate
Base colour : RAL_7035
Cover colour : RAL 7035 -light grey
Gasket material : Polyurethane

Temperatures :

Temperature °C (continuous) : -40 ... 80
Temperature °F (continuous) : -40 ... 175

(148 x 148 x 1.5)

MIV 15 DIN-35 Mounting rail, for enclosures:
(150 x 35 x 7)

FP 22046 Wall fastening lug (4 pcs)
(35 x 16 x 10)

Ratings :

Ingress protection (EN 60529): IP66; IP67;
Impact Resistance (EN 62262): IK08;
electrical_insulation : Totally insulated
Halogen free (DIN/VDE 0472, Part 815) : Yes
UV resistance : UL 746C
Flammability Rating : UL 94 V0
Glow Wire Test (IEC 695-2-1) °C : 960C

Certificates :

Certificate FI 40847