

PCM 150/85 XT



Sample image

Order symbol : PCM 150/85 XT

Product nr : 6016933

Description : Enclosure, PC, metric knock-outs

Remarks : Extra high base, smoked transparent cover

EAN : 6418074061461

El. number :

- Finland : 3435664
- Denmark : 8212027844
- Sweden : 2535466

Including : Base with TPE gasket. screws for mounting plate/DIN-rail and cover with polyamide cover screws.

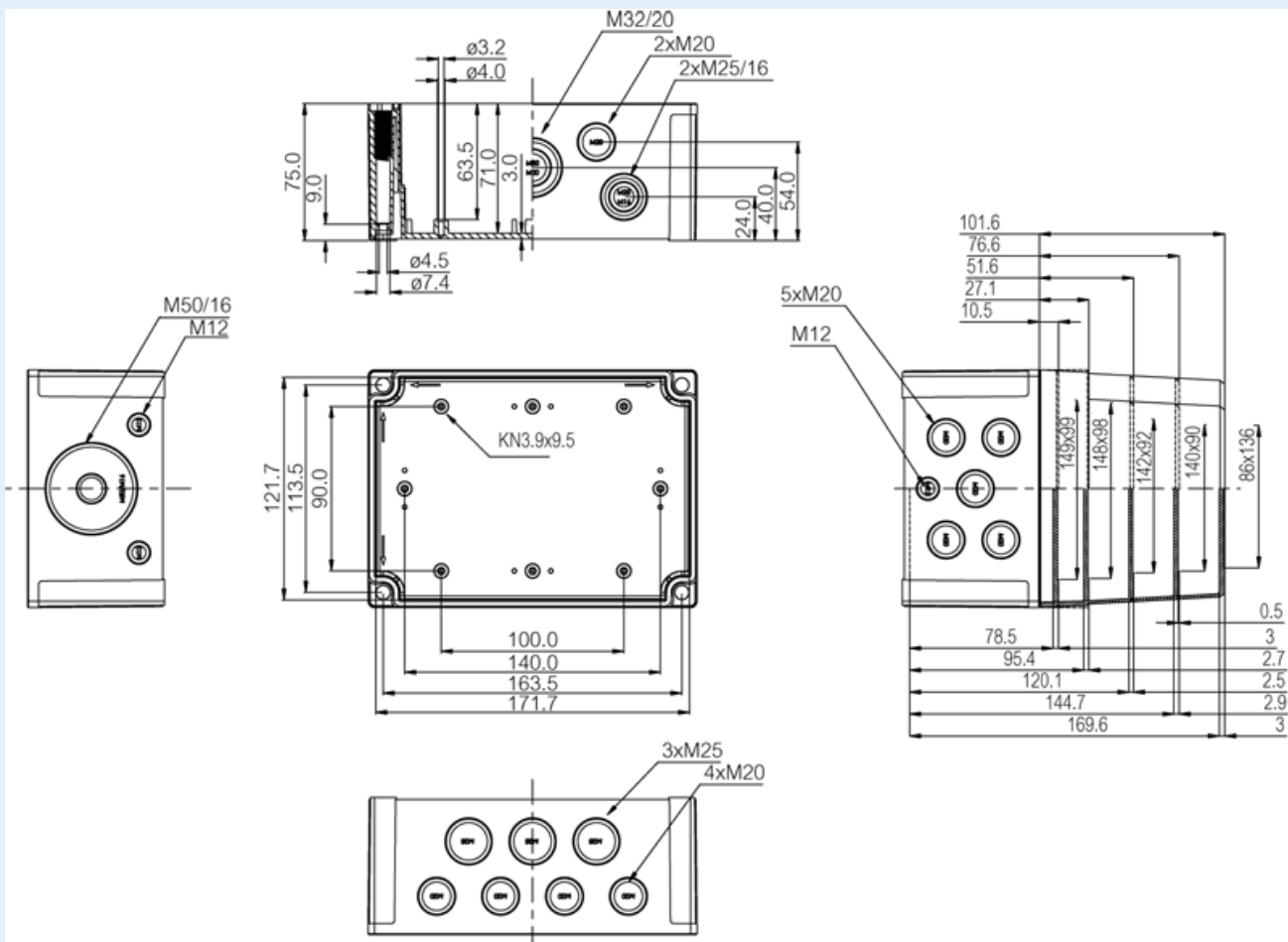

Dimensions :

	Height	Width	Depth
mm :	180	130	85
inch :	7.09	5.12	3.35

Materials :

Material :	Polycarbonate
Base colour :	RAL_7035
Cover colour :	Clear transparent
Gasket material :	Polyurethane

Temperatures :

Temperature °C (continuous) :	-40 ... 80
Temperature °F (continuous) :	-40 ... 175

Accessories :

MIV 10	DIN-35 Mounting rail, for enclosures: (100 x 35 x 7)
MIV 150	Mounting plate (Galvanized steel), for enclosures: (148 x 98 x 1.5)
MIV 15	DIN-35 Mounting rail, for enclosures: (150 x 35 x 7)
FP 22046	Wall fastening lug (4 pcs) (35 x 16 x 10)

Ratings :

Ingress protection (EN 60529):	IP66; IP67;
Impact Resistance (EN 62262):	IK08;
electrical_insulation :	Totally insulated
Halogen free (DIN/VDE 0472, Part 815) :	Yes
UV resistance :	UL 746C
Flammability Rating :	UL 94 V0
Glow Wire Test (IEC 695-2-1) °C :	960C

Certificates :

Certificate FI 40847