

ABS 200/63 HT

Sample image

Order symbol : ABS 200/63 HT

EAN : 6418074052001

Product nr : 6081924

El. number :

Description : Enclosure, ABS

- Finland : 3435278
- Denmark : 8212023686
- Sweden : 2535869

Remarks : High base, smoked transparent cover

Including : Base with TPE gasket. screws for mounting plate/DIN-rail and cover with polyamide cover screws.

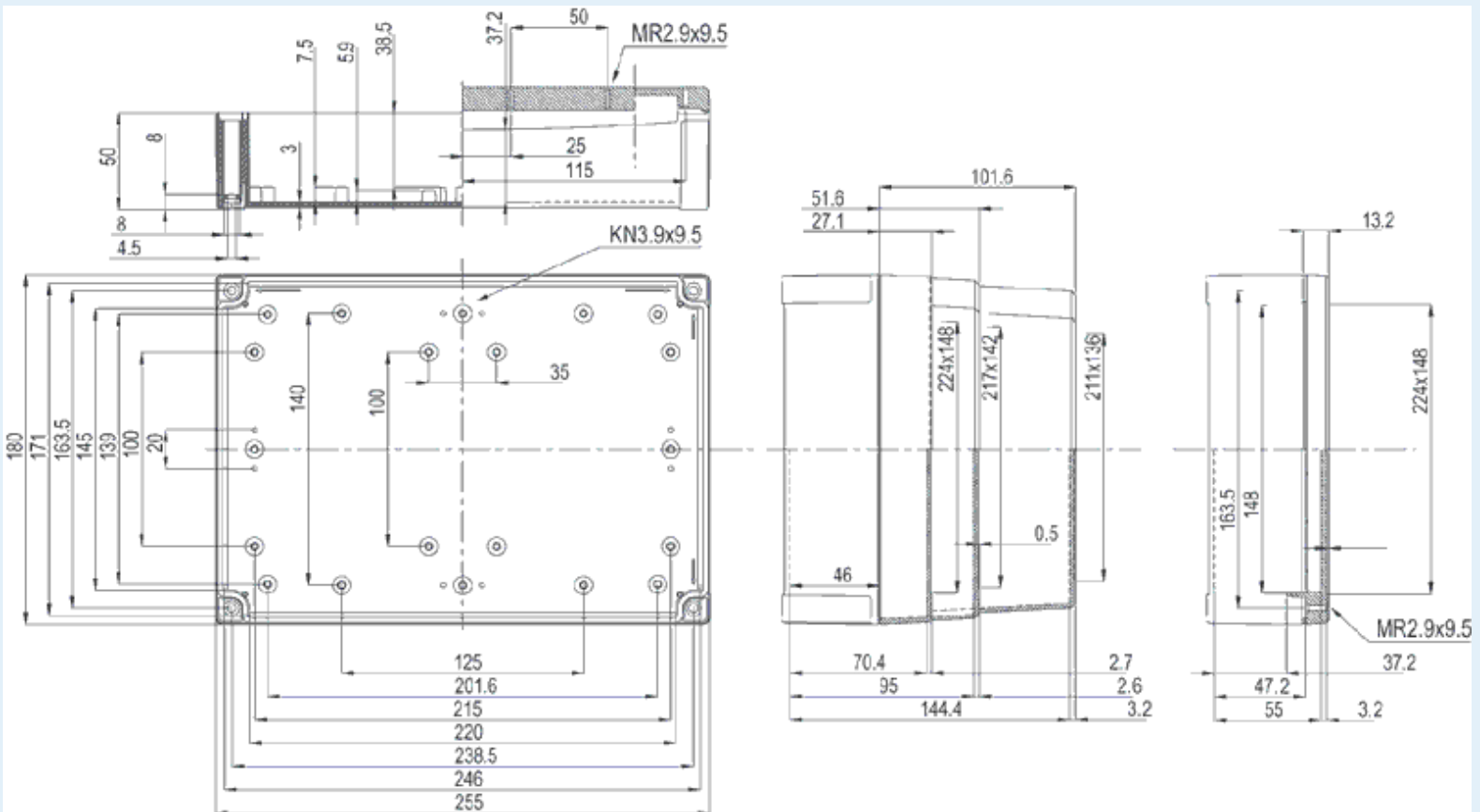

Dimensions :	Height	Width	Depth
mm :	255	180	63
inch :	10.04	7.09	2.48

Materials :

Material : ABS
Base colour : RAL_7035

Accessories :

- MIV 200 Mounting plate (Galvanized steel), for enclosures: (223 x 148 x 1.5)
- MIV 15 DIN-35 Mounting rail, for enclosures: (150 x 35 x 7)
- FP 22046 Wall fastening lug (4 pcs) (35 x 16 x 10)
- MIV 20 DIN-35 Mounting rail, for enclosures: (225 x 35 x 7)

Cover colour : Clear transparent

Gasket material : Polyurethane

Temperatures :

Temperature °C (continuous) : -40 ... 60

Temperature °F (continuous) : -40 ... 140

Ratings :

Ingress protection (EN 60529): IP66; IP67;

Impact Resistance (EN 62262): IK07;

electrical_insulation : Totally insulated

Halogen free (DIN/VDE 0472, Part 815) : Yes

UV resistance : -

Flammability Rating : UL 94 HB

Glow Wire Test (IEC 695-2-1) °C : 650C

Certificates :

Certificate FI 41115