

# ABS 150/85 XHG

Sample image

**Order symbol :** ABS 150/85 XHG

**EAN :** 6418074061317

**Product nr :** 6083333

**El. number :**

**Description :** Enclosure, ABS

- Finland : 3435628
- Denmark : 8212028283
- Sweden : 6083333

**Remarks :** Extra high base, grey cover

**Including :** Base with PUR gasket. screws for mounting plate/DIN-rail and cover with polyamide cover screws.

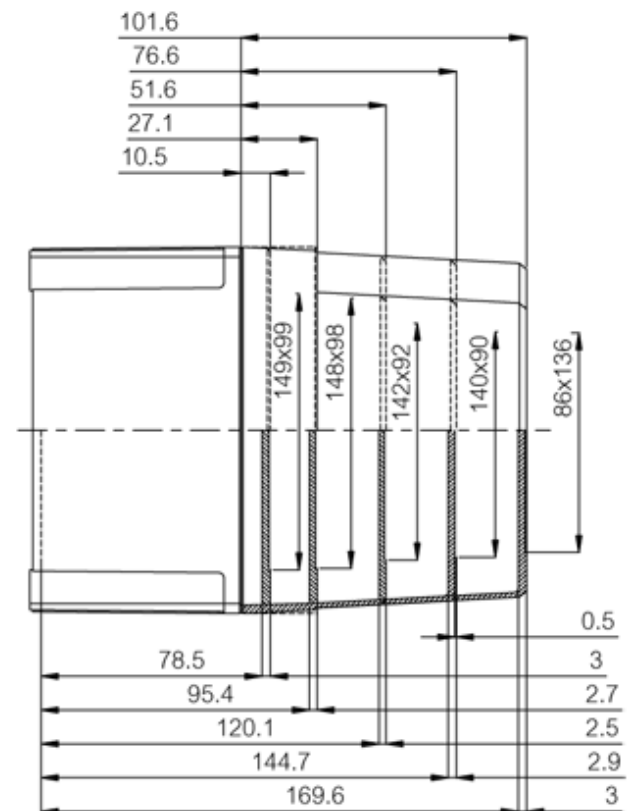
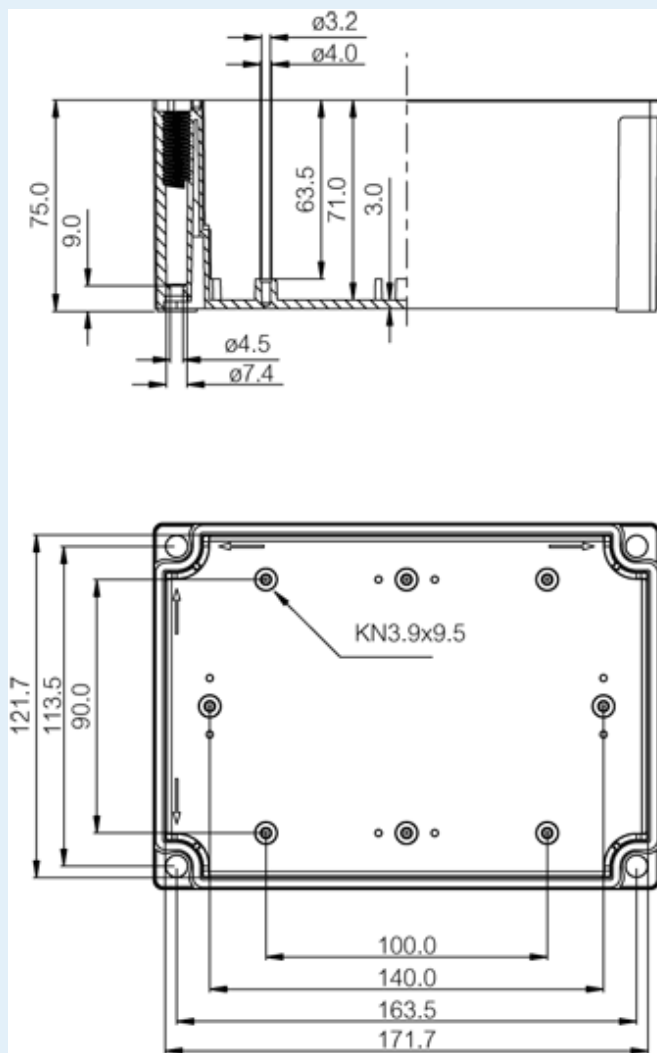

Dimensions :	Height	Width	Depth
mm :	180	130	85

Accessories :	
MIV 10	DIN-35 Mounting rail, for enclosures: (100 x 35 x 7)

inch : 7.09 5.12 3.35

**Materials :**

Material : ABS  
Base colour : RAL\_7035  
Cover colour : RAL 7035 -light grey  
Gasket material : Polyurethane

**Temperatures :**

Temperature °C (continuous) : -40 ... 60  
Temperature °F (continuous) : -40 ... 140

MIV 150 Mounting plate (Galvanized steel), for enclosures:  
(148 x 98 x 1.5)  
MIV 15 DIN-35 Mounting rail, for enclosures:  
(150 x 35 x 7)  
FP 22046 Wall fastening lug (4 pcs)  
(35 x 16 x 10)

**Ratings :**

Ingress protection (EN 60529): IP66; IP67;  
Impact Resistance (EN 62262): IK07;  
electrical\_insulation : Totally insulated  
Halogen free (DIN/VDE 0472, Part 815) : Yes  
UV resistance : -  
Flammability Rating : UL 94 HB  
Glow Wire Test (IEC 695-2-1) °C : 650C

**Certificates :**

Certificate FI 41115