

ABS 150/175 XHG

Sample image

Order symbol : ABS 150/175 XHG

EAN : 6418074061355

Product nr : 6083337

El. number :

Description : Enclosure, ABS

- Finland : 3435636
- Denmark : 8212028267
- Sweden : 6083337

Remarks : Extra high base, grey cover

Including : Base with PUR gasket. screws for mounting plate/DIN-rail and cover with polyamide cover screws.

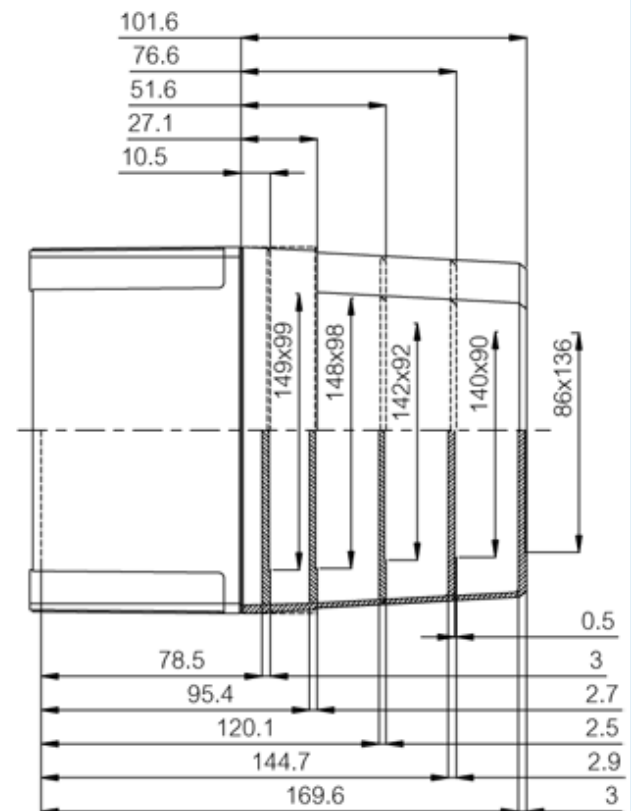
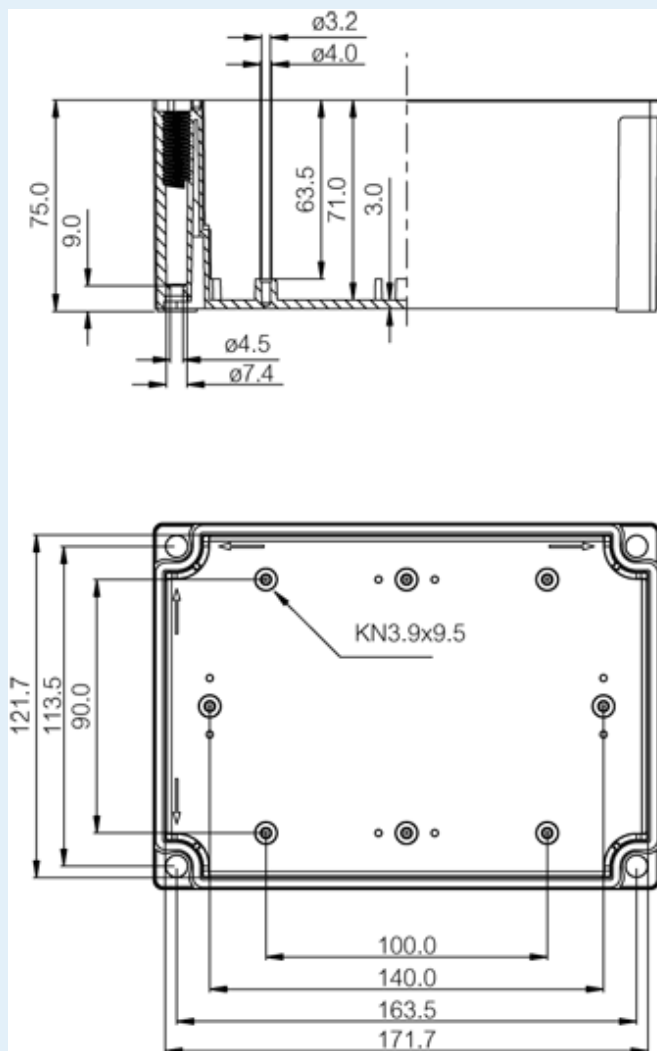

Dimensions :	Height	Width	Depth
mm :	180	130	175

Accessories :	
MIV 10	DIN-35 Mounting rail, for enclosures: (100 x 35 x 7)

inch : 7.09 5.12 6.89

Materials :

Material : ABS
Base colour : RAL_7035
Cover colour : RAL 7035 -light grey
Gasket material : Polyurethane

Temperatures :

Temperature °C (continuous) : -40 ... 60
Temperature °F (continuous) : -40 ... 140

MIV 150 Mounting plate (Galvanized steel), for enclosures:
(148 x 98 x 1.5)

MIV 15 DIN-35 Mounting rail, for enclosures:
(150 x 35 x 7)

FP 22046 Wall fastening lug (4 pcs)
(35 x 16 x 10)

Ratings :

Ingress protection (EN 60529): IP66; IP67;
Impact Resistance (EN 62262): IK07;
electrical_insulation : Totally insulated
Halogen free (DIN/VDE 0472, Part 815) : Yes
UV resistance : -
Flammability Rating : UL 94 HB
Glow Wire Test (IEC 695-2-1) °C : 650C

Certificates :

Certificate FI 41115