

# ABS 150/85 XHT



Sample image

**Order symbol :** ABS 150/85 XHT

**Product nr :** 6083933

**Description :** Enclosure, ABS

**Remarks :** Extra high base, smoked transparent cover

**EAN :** 6418074061362

**El. number :**

- Finland : 3435640
- Denmark : 8212028296
- Sweden : 6083933

**Including :** Base with TPE gasket. screws for mounting plate/DIN-rail and cover with polyamide cover screws.

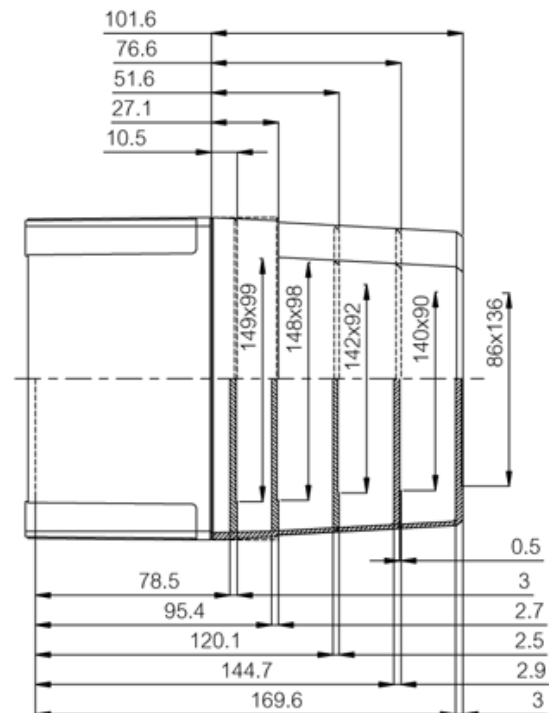
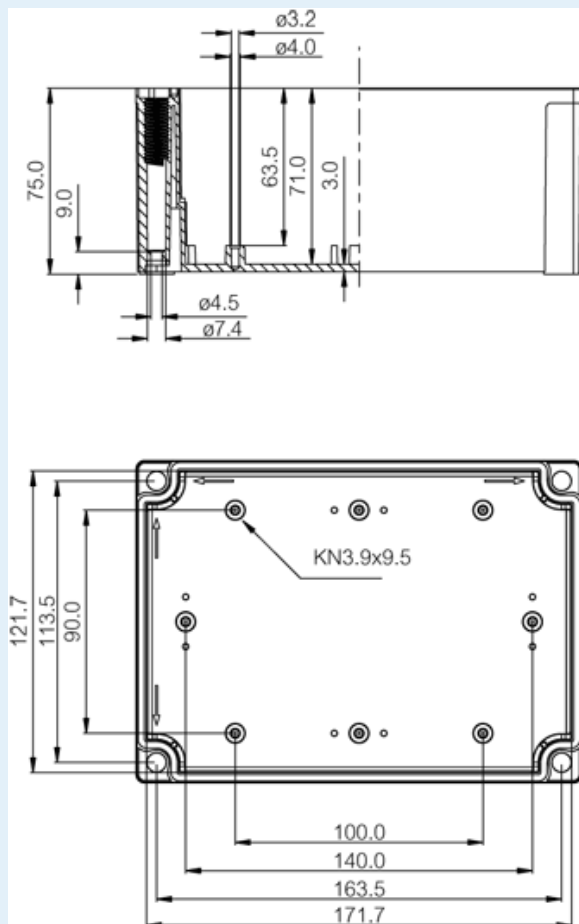

<b>Dimensions :</b>	<b>Height</b>	<b>Width</b>	<b>Depth</b>
mm :	180	130	85
inch :	7.09	5.12	3.35

#### **Materials :**

Material :	ABS
Base colour :	RAL_7035
Cover colour :	Clear transparent
Gasket material :	Polyurethane

#### **Temperatures :**

Temperature °C (continuous) :	-40 ... 60
Temperature °F (continuous) :	-40 ... 140

#### **Accessories :**

MIV 10	DIN-35 Mounting rail, for enclosures: (100 x 35 x 7)
MIV 150	Mounting plate (Galvanized steel), for enclosures: (148 x 98 x 1.5)
MIV 15	DIN-35 Mounting rail, for enclosures: (150 x 35 x 7)
FP 22046	Wall fastening lug (4 pcs) (35 x 16 x 10)

#### **Ratings :**

Ingress protection (EN 60529):	IP66; IP67;
Impact Resistance (EN 62262):	IK07;
electrical_insulation :	Totally insulated
Halogen free (DIN/VDE 0472, Part 815) :	Yes
UV resistance :	-
Flammability Rating :	UL 94 HB
Glow Wire Test (IEC 695-2-1) °C :	650C

#### **Certificates :**

Certificate FI 41115