

ABS B 85 T

Sample image

Order symbol : ABS B 85 T

EAN : 6418074002006

Product nr : 8784004

El. number :

Description : Enclosure, ABS

- Finland : 3423553
- Denmark : 8212001831
- Sweden : 2536735

Remarks : Transparent cover

Including : Base with screws for mounting plate/DIN-rail. cover with PUR gasket and polyamide cover screws.

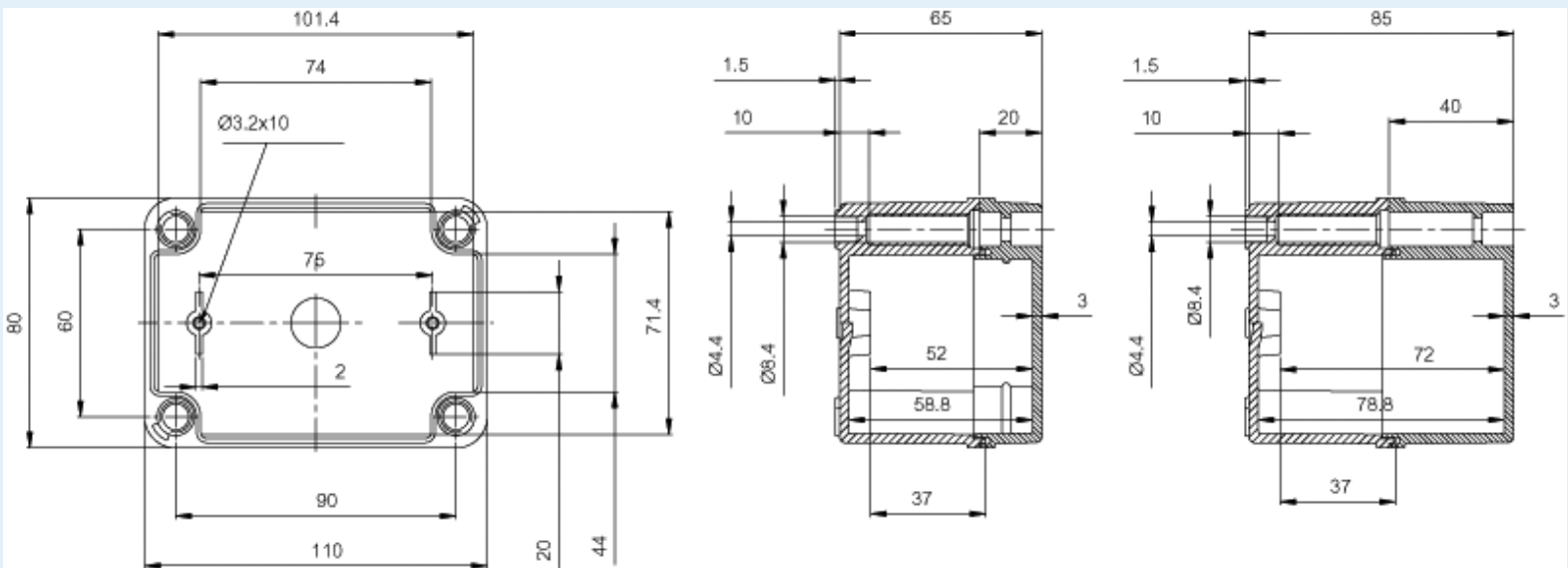

Dimensions :	Height	Width	Depth
mm :	110	80	85
inch :	4.33	3.15	3.35

Accessories :

- B-MP Mounting plate, for enclosures:
(80 x 54 x 1.5)
- B-3 DIN-35 Mounting rail, for enclosures:
(80 x 35 x 7)

Materials :

Material :	ABS
Base colour :	RAL 7035 -light grey
Gasket material :	Polyurethane

Temperatures :

Temperature °F (continuous) :	-40 ... 140
-------------------------------	-------------

Ratings :

Ingress protection (EN 60529):	IP66; IP67;
Impact Resistance (EN 62262):	IK08;
electrical_insulation :	Totally insulated
Halogen free (DIN/VDE 0472, Part 815) :	Yes
UV resistance :	-
Flammability Rating :	UL 94 HB
Glow Wire Test (IEC 695-2-1) °C :	650C

Certificates :

SGSFIMKO_PICC_pc