

ABS B 85 G



Sample image

Order symbol : ABS B 85 G

Product nr : 8784304

Description : Enclosure, ABS

Remarks : Grey cover

EAN : 6418074002013

El. number :

- Finland : 3423453
- Denmark : 8212001828
- Sweden : 2536704

Including : Base with screws for mounting plate/DIN-rail. cover with PUR gasket and polyamide cover screws.

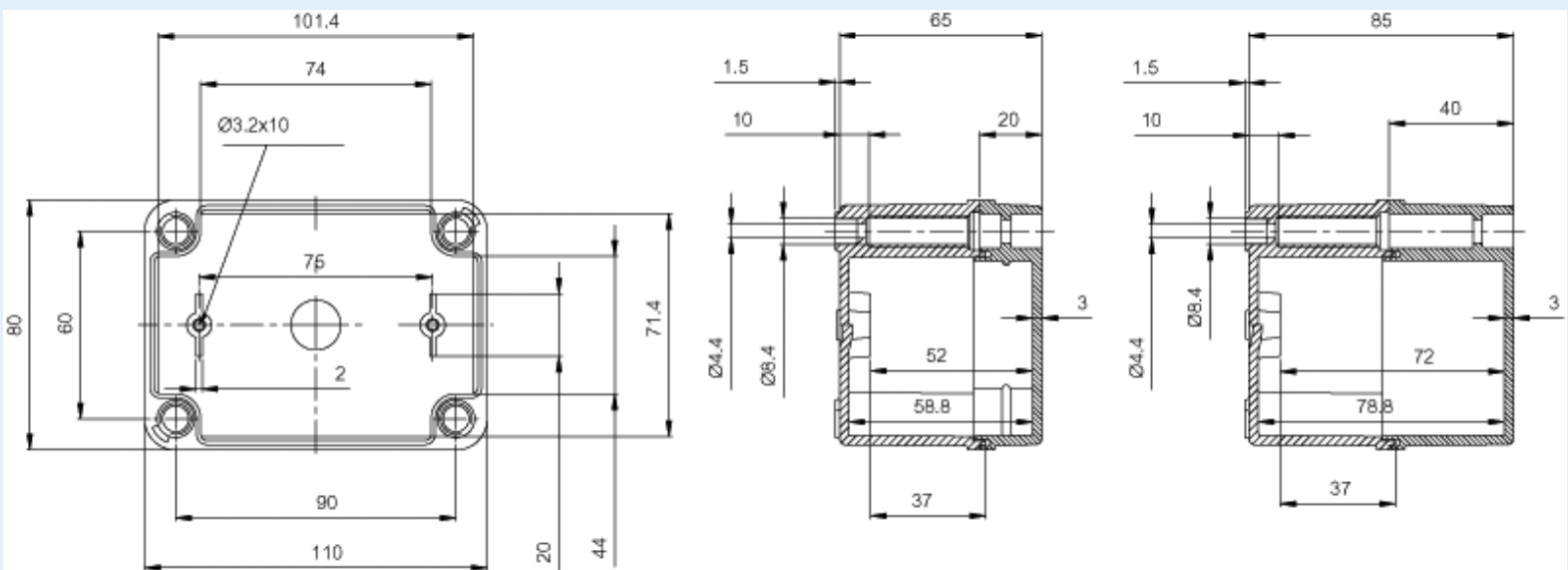

Dimensions :	Height	Width	Depth
mm :	110	80	85
inch :	4.33	3.15	3.35

Materials :

Material :	ABS
Base colour :	RAL_7035
Cover colour :	RAL 7035 -light grey
Gasket material :	Polyurethane

Accessories :

B-MP	Mounting plate, for enclosures: (80 x 54 x 1.5)
B-3	DIN-35 Mounting rail, for enclosures: (80 x 35 x 7)

Ratings :

Ingress protection (EN 60529):	IP66; IP67;
Impact Resistance (EN 62262):	IK08;
electrical_insulation :	Totally insulated
Halogen free (DIN/VDE 0472, Part 815) :	Yes

Temperatures :

Temperature °C (continuous) : -40 ... 60
Temperature °F (continuous) : -40 ... 140

UV resistance :

-

Flammability Rating :

UL 94 HB

Glow Wire Test (IEC 695-2-1) °C :

650C

Certificates :

SGSFIMKO_PICC_pc