

# ABS D 85 G



Sample image

**Order symbol :** ABS D 85 G

**Product nr :** 8784308

**Description :** Enclosure, ABS

**Remarks :** Grey cover

**EAN :** 6418074002174

**El. number :**

- Finland : 3423461
- Denmark : 8212001912
- Sweden : 2536717

**Including :** Base with screws for mounting plate/DIN-rail. cover with PUR gasket and polyamide cover screws.

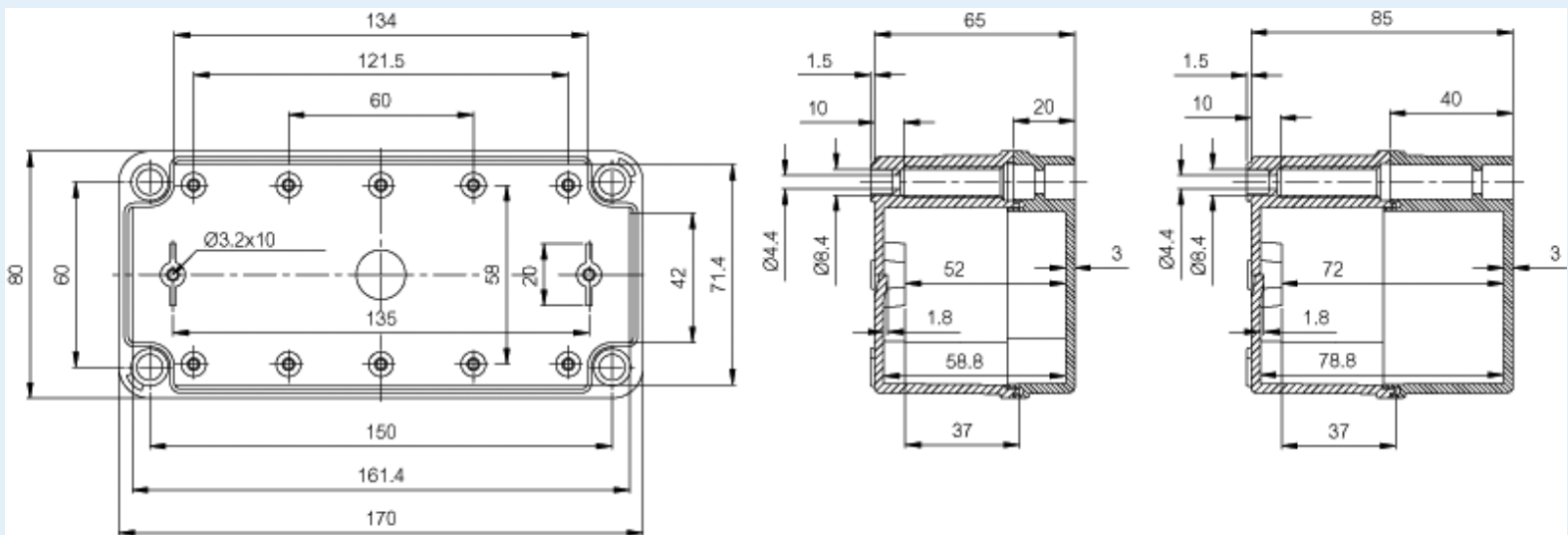

Dimensions :	Height	Width	Depth
mm :	170	80	85
inch :	6.69	3.15	3.35

## Materials :

Material :	ABS
Base colour :	RAL_7035
Cover colour :	RAL 7035 -light grey
Gasket material :	Polyurethane

## Accessories :

DH-3	DIN-35 Mounting rail, for enclosures: (140 x 35 x 7)
D-MP	Mounting plate, for enclosures: (140 x 54 x 1.5)

## Ratings :

Ingress protection (EN 60529):	IP66; IP67;
Impact Resistance (EN 62262):	IK08;
electrical_insulation :	Totally insulated
Halogen free (DIN/VDE 0472, Part 815) :	Yes
UV resistance :	-

**Temperatures :**

Temperature °C (continuous) : -40 ... 60  
Temperature °F (continuous) : -40 ... 140

Flammability Rating :

UL 94 HB

Glow Wire Test (IEC 695-2-1) °C :

650C

**Certificates :**

SGSFIMKO\_PICC\_pc